

# SPECIFICATION FOR APPROVAL

CUSTOMER : \_\_\_\_\_

PRODUCT TYPE : SMD GLASS SEALING X'TAL 3.2\*2.5

NOMINAL FREQ. : 12.000000MHz

TXC P/N : 7V12000012

REVISION : A1

CUSTOMER P/N : \_\_\_\_\_

PM / SALES : \_\_\_\_\_

DATE : \_\_\_\_\_

CUSTOMER SIGNATURE & Date \_\_\_\_\_

- (1) TXC requires one copy returned with signature and title of authorized individual that signifies acceptance of the attached specifications.
- (2) Orders received and accepted by TXC after return of signed copy of specification will be produced per these specifications.
- (3) Any changes to these specifications must be agreed upon by both parties and new revision of the Product Specification Sheet will be issued.
- (4) Any issuance of purchase order prior to consigning back the Approval page of "Specification Sheets" from customers will be regarded as the agreement on the contents of these specifications.

**MSL:Level 1  
RoHS Compliant**

Pb used in sealing glass material is exempt from EU directive

# PRODUCT SPECIFICATION SHEET

PRODUCT TYPE : SMD GLASS SEALING X'TAL 3.2\*2.5

---

NOMINAL FREQ. : 12.000000MHz



---

TXC P/N : 7V12000012

---

REVISION : A1

---

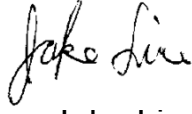
PE/RD	QA	MFG
 Robin Huang	 Samson Xiong	 Jake Liu
24-Mar-15	24-Mar-15	24-Mar-15

**NOTE:**

(1)The green product standard set by TXC is based upon the international standards. Related information is publicly described on the TXC's Website, and updated regularly. The document is compliant with the latest green product quality system directives at the time.

(2)Revision "Sx" is for engineering samples only. PE/RD's approval required.

(3)Revision "Ax" is production ready. PE, QA and MFG's approval required

**MSL:Level 1**  
**RoHS Compliant**

Pb used in sealing glass material is exempt from EU directive

<u>Rev</u>	<u>Revise page</u>	<u>Revise contents</u>	<u>Date</u>	<u>Ref.No.</u>	<u>Reviser</u>
S1	N/A	Initial released	22-Oct-09	N/A	Xiaoyan Jiang
S2	7	Increase Contents	11-Oct-11	N/A	Xiaoyan Jiang
A1	N/A	S Turn A	24-Mar-15	N/A	Xiaoyan Jiang



## Spec Sheet Contents

No.	Content	Page
1	ELECTRICAL SPECIFICATIONS	P.3
2	FACTORY LOCATION	P.3
3	DIMENSIONS	P.4
4	MARKING	P.4
5	SUGGESTED REFLOW PROFILE& MANUAL SOLDER CONDITION	P.4
6	STRUCTURE ILLUSTRATION	P.5
7	EMBOSS CARRIER TAPE & REEL	P.6
8	PACKING	P.7
9	RELIABILITY SPECIFICATIONS	P.8~9



**ELECTRICAL SPECIFICATIONS****Standard atmospheric conditions**

Unless otherwise specified, the standard range of atmospheric conditions for making measurement and tests are as follow:

Ambient temperature : 25±5°C  
Relative humidity : 40%~70%

If there is any doubt about the results, measurement shall be made within the following limits:

Ambient temperature : 25±3°C  
Relative humidity : 40%~70%

**Measure equipment**

Electrical characteristics measured by S&A250B or equivalent.

**Crystal cutting type**

The crystal is using AT CUT (thickness shear mode).

**Unit Weight:**

0.018±0.001 g/pcs

	Parameters	SYM.	Electrical Spec.				Notes
			MIN	TYP	MAX	UNITS	
1	Nominal Frequency	FL	12.000000			MHz	-
2	Oscillation Mode	-	Fundamental			-	-
3	Load Capacitance	CL	15			pF	-
4	Frequency Tolerance	-	±20			ppm	at 25 ± 3 °C
5	Frequency Stability	-	±20			ppm	Over Operating Temp. Range (Reference 25°C)
6	Operating Temperature	-	-10	~	70	°C	-
7	Aging	-	±3			ppm	1st Year
8	Drive Level	DL	-	10	-	uW	-
9	Equivalent Resistance Rr	Rr	-	-	80	Ω	-
10	Shunt Capacitance C0	C0	-	-	3	pF	-
11	Insulation Resistance	-	500	-	-	MΩ	at DC 100V
12	Storage Temperature Range	-	-40	~	85	°C	-

**FACTORY LOCATION**

TXC (NINGBO) CORPORATION  
NO.189 Huang Shan West Road, Beilun District,  
Ningbo Zhejiang China

**■ DIMENSIONS**

(Unit:mm)

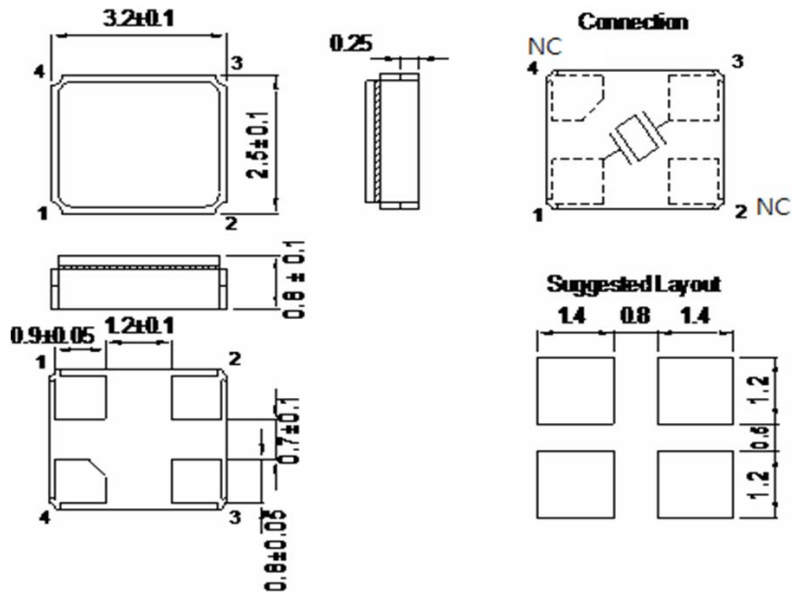

\*Coplanarity of solderable areas Camber 0.10 mm Max

**■ MARKING**

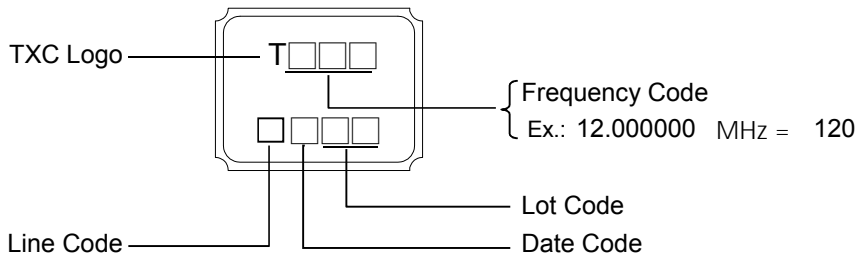

**Date Code:**

YEAR \ MONTH				MONTH											
				JAN	FEB	MAR	APR	MAY	JUN	JUL	AUG	SEP	OCT	NOV	DEC
2005	2009	2013	2017	A	B	C	D	E	F	G	H	J	K	L	M
2006	2010	2014	2018	N	P	Q	R	S	T	U	V	W	X	Y	Z
2007	2011	2015	2019	a	b	c	d	e	f	g	h	j	k	l	m
2008	2012	2016	2020	n	p	q	r	s	t	u	v	w	x	y	z

\*This date code will be cycled every four years

**■ SUGGESTED REFLOW PROFILE**

Solder melting point :220±10 °C, 60 sec. Min.  
Peak Temperature: 260 ± 5 °C, 10 sec. Max.

**■ SUGGESTED MANUAL SOLDER CONDITION**

Temperature: 350 ± 10 °C  
Time: 3 sec.  
Re-solder times: twice

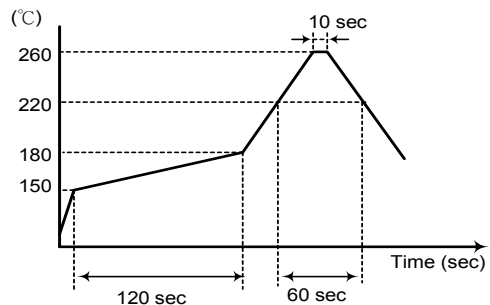



■ STRUCTURE ILLUSTRATION

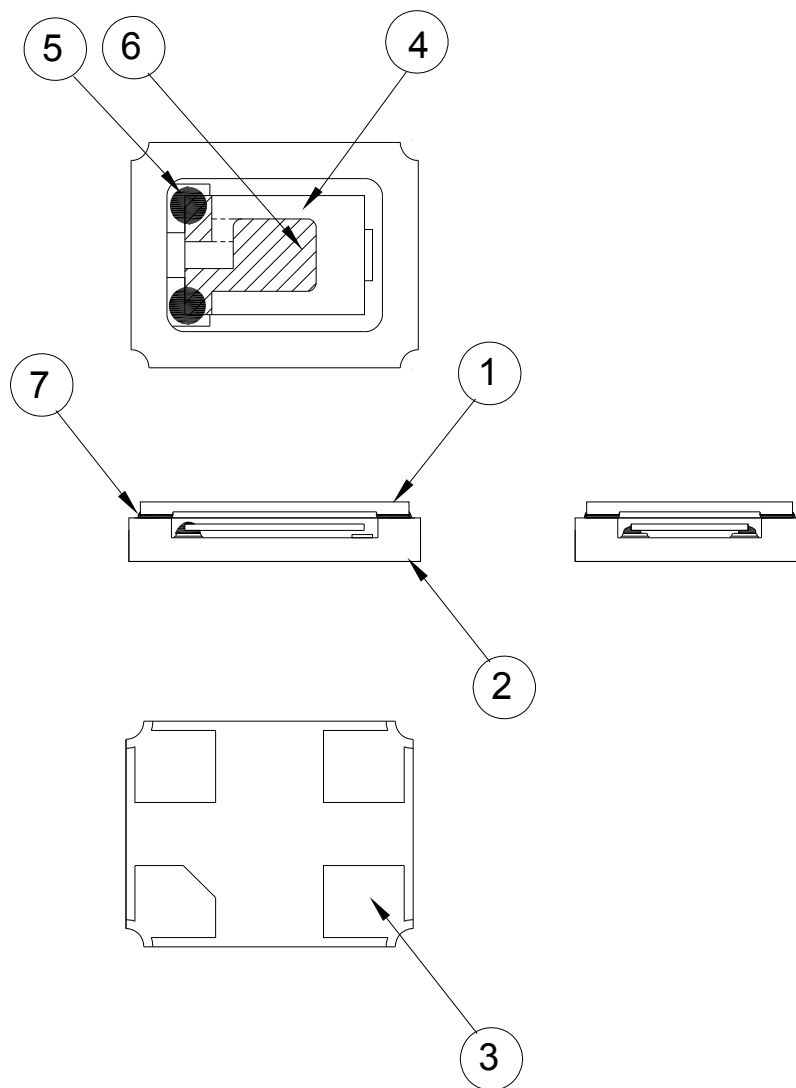

NO	COMPONENTS	MATERIALS	FINISH/SPECIFICATIONS
1	Cap	Ceramic (Al <sub>2</sub> O <sub>3</sub> )	-
2	Package	Ceramic (Al <sub>2</sub> O <sub>3</sub> )	-
3	PAD	Au	Tungsten metalize + Ni plating + Au plating
4	Crystal blank	SiO <sub>2</sub>	-
5	Conductive adhesive	Resin+Ag	-
6	Electrode	Ag	-
7	Sealing Glass	Glass(PbO)	-



■ EMOSS CARRIER TAPE & REEL

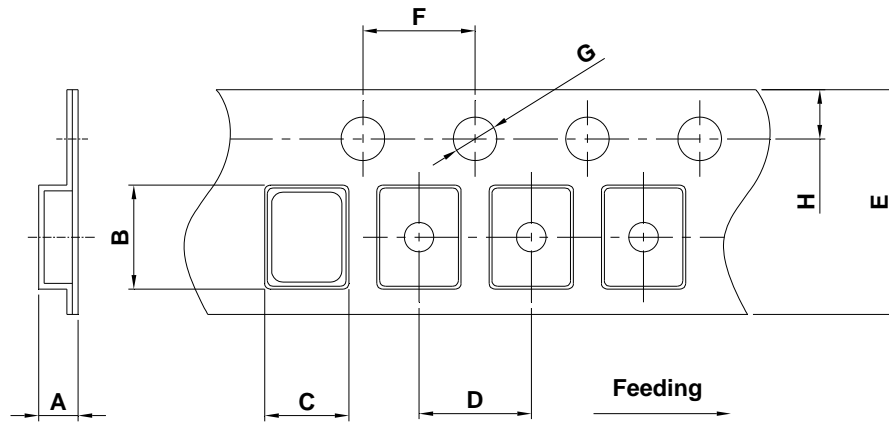

DIMENSIONS	A	B	C	D	E	F	G	H	
	1.65±0.10	3.40±0.10	2.70±0.10	4.00±0.10	8.00±0.20	4.00±0.10	1.55±0.10	1.75±0.10	(UNIT : mm)

REMARK :

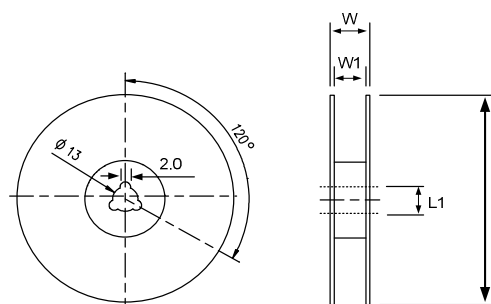
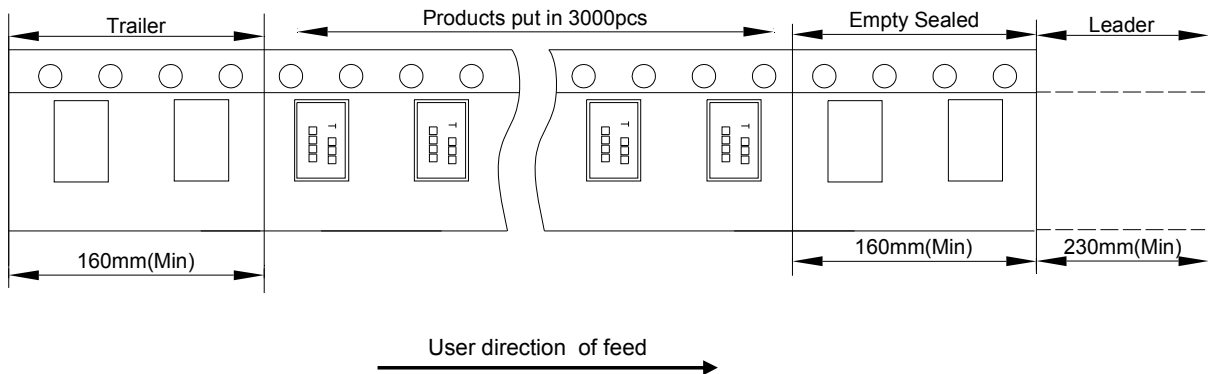

DIMENSIONS	L	L1	W	W1	
	178±1.00	13±0.50	11.5±0.20	8±0.10	(UNIT : mm)



**PACKING**

Reel Quantity :

- 1. Reel X 6 (6 Reels)
- 2. Reel X 12 (12 Reels)
- 3. Reel X 25 (12 Reels + 13 Reels)
- 4. Reel X 50 (12 Reelsx2 + 13 Reelsx2)

Box Size:

- 1. L200 X W200 X H140mm
- 2. L200 X W200 X H250mm
- 3. L400 X W200 X H250mm
- 4. L400 X W400 X H280mm

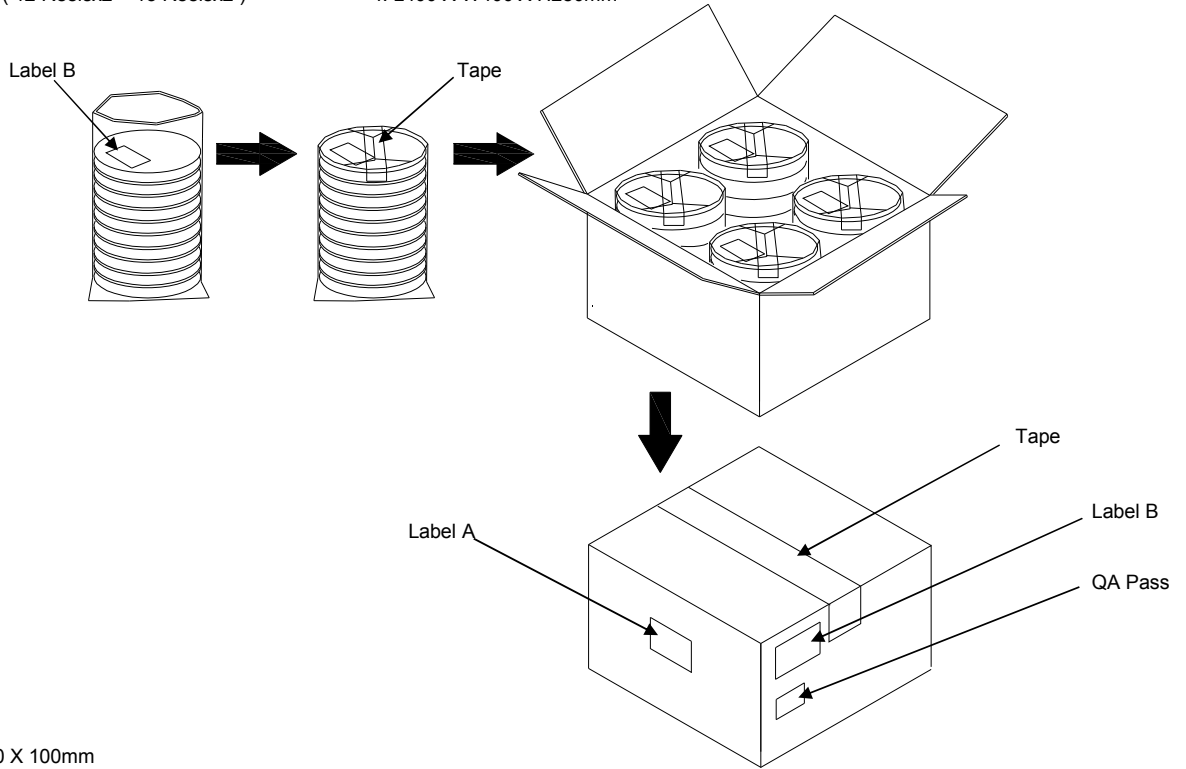

(Label A) Size:100 X 100mm

TXC
Inv No: 00096815
Po No: 21106326- 24- 1
Part No: <span style="font-family: monospace;">□□□□□□□□</span>
Qty: 40000 PCS
C/No: 157- 44

(Label B) Size:80 X 40mm

TXC CORPORATION		QA PASS
DATE CODE:	QTY:	2011/09/02
<span style="font-family: monospace;">□□□□□□□□</span>		<span style="font-family: monospace;">□□□□</span>
LOT NO:	<b>RoHS</b>	
PART NO:	<b>HF</b>	
FREQ: <span style="font-family: monospace;">□□□□□□□□</span>		

**[STORAGE]**

- 1.The storage time to be 1 year maximum.
- 2.Don't be caught in the rain.
- 3.The storage environment shall be 5°C ~40°C temperature and 30% ~ 75%RH humidity and free from the sun shine.
- 4.If customers have special requirements, we can paste labels according to it.



**■ RELIABILITY SPECIFICATIONS**
**1.Mechanical Endurance**

No.	Test Item	Test Methods	Test Criteria
1.1	Drop Test	150 cm height,3 times on concrete floor .	A . C
1.2	Mechanical Shock	Device are shocked to half sine wave ( 1000 G ) three mutually perpendicular axes each 3 times. 0.5 ms duration time	A . C
1.3	Vibration	Frequency range                      10 ~ 2000 Hz Amplitude                                    1.52 mm/20G Sweep time                                 20 minutes Perpendicular axes each test time    4 Hrs (Total test time 12 Hrs)	A . C
1.4	Solderability	Temperature                                245 °C ± 5°C Immersing depth                            0.5 mm minimum Immersion time                             5 ± 1 seconds Flux    Rosin resin methyl alcohol solvent ( 1 : 4 )	E

**2.Environmental Endurance**

No.	Test Item	Test Methods	Test Criteria
2.1	Resistance To Soldering Heat	Pre-heat temperature                      125 °C Pre-heat time                                60 ~ 120 sec. Test temperature                             260 ± 5 °C Test time                                        10 ± 1 sec.	B . C . D
2.2	High Temp. Storage	+ 125 °C ± 3 °C for 500 ± 12 Hrs	B . C . D
2.3	Low Temp. Storage	- 40 °C ± 3 °C for 500 ± 12 Hrs	B . C . D
2.4	Temperature cycle	Total 100 cycles of the following temperature cycle 	B . C . D
2.5	High Temp & Humidity	85°C ± 3°C , RH 85% , 500 Hrs	B . C . D





**RELIABILITY SPECIFICATIONS**

Specifications	
A	Frequency change: Within $\pm 5$ ppm or in customer's specification.
B	Frequency change: Within $\pm 10$ ppm or in customer's specification.
C	Equivalent series resistance(E.S.R) change: Within $\pm 15\%$ or $10\Omega$ (larger value).
D	After conditioning , quartz crystal units shall be subjected to standard atmospheric conditions for 2 hour, and measured.
E	Minimum 95% of immersed terminal shall be covered with new uniform solder.

**Measurement condition**

Electrical characteristics measured by S&A250B or equivalent.